

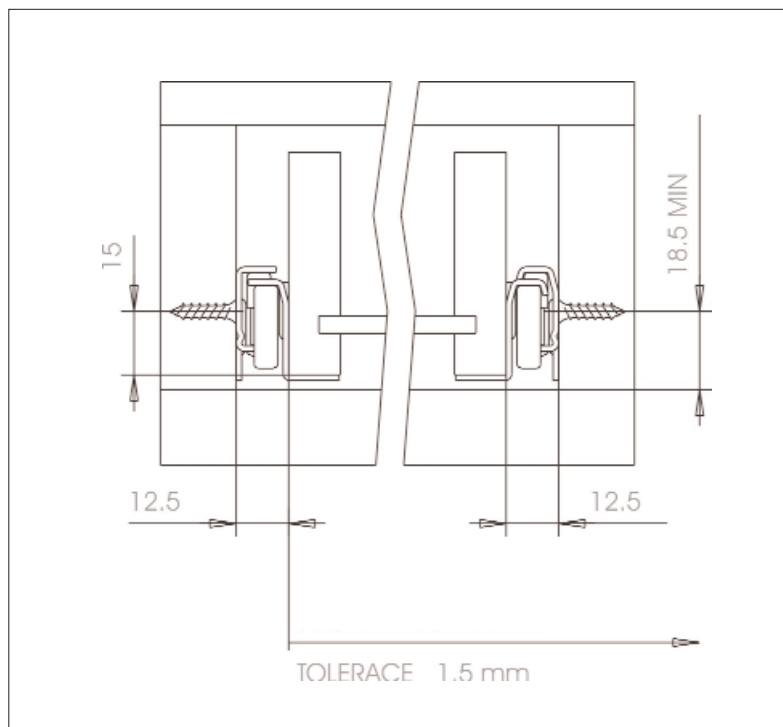

- Self-closing drawer slides
- Double stop
- Load capacity: 25kg
- Thickness: 1 - 1,2mm
- Lengths available: from 250 to 600mm

Mounting instructions



Ferrari hold the right to alter or amend any technical or structural specifications at any time without notice

ITALY

Agostino Ferrari S.p.a.
I - 23878 Verderio S. (LC) Via per Cornate
Tel. ++39.039.59001 - Fax ++39.039.5900222
Web Site://www.ferrarispa.it - e-mail: ferrarispa@ferrarispa.it

U.S.A.

Ferrari America INC.
4189 Eagle Hill Drive - Suite 110 - High Point - North Carolina - 27265 - U.S.A.
Tel. 001 336 8411445 - Fax 001 336 8413543
Web Site://www.ferrariamerica.com - e-mail: info@ferrariamerica.com

GREECE

Ferrari Greece LTD
101 Syngrou Avenue - 11745 Athens -Greece
Tel. 0030 210 9211838 - Fax 0030 210 9211836
e-mail: ferrarinikos@internet.gr

GERMANY

Agostino Ferrari Germany GMBH
Im Meisenfeld 5 - 32602 Vlotho - Exter Germany
Tel. 0049 5228 96080 - Fax 0049 5228 960824
Web Site://www.ferrari-fittings.de - e-mail: ferrari@ferrari-fittings.de

U.K.

Agostino Ferrari (UK) LTD Units H & L
Strawberry Street Industrial Estate HU9 1EN Hull East Yorkshire - U.K.
Tel. 0044 1482 594450 - Fax 0044 1482 594455
Web site://www.aferrariuk.com - e-mail: info@aferrariuk.com

Fixing systems

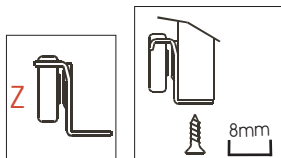
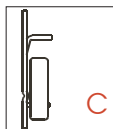

3.5x13mm woodscrews
or 8mm staples

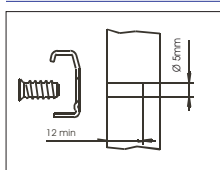

Euroscrews 6.3x13mm

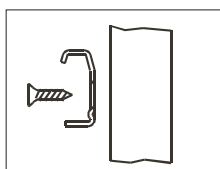

3.5x13mm woodscrews

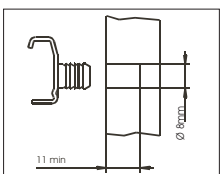

Knock-in by premounted \varnothing 8mm
dowels (T). \varnothing 10mm on request

With thickness 1,2mm

Length	Code	Extension
250mm	GS250TV**	166mm
300mm	GS300TV**	216mm
350mm	GS350TV**	266mm
400mm	GS400TV**	316mm
450mm	GS450TV**	355mm
500mm	GS500TV**	398mm
550mm	GS550TV**	448mm
600mm	GS600TV**	498mm

With thickness 1mm

Length	Code	Extension
250mm	GS250SV**	166mm
300mm	GS300SV**	216mm
350mm	GS350SV**	266mm
400mm	GS400SV**	316mm
450mm	GS450SV**	355mm
500mm	GS500SV**	398mm
550mm	GS550SV**	448mm
600mm	GS600SV**	498mm

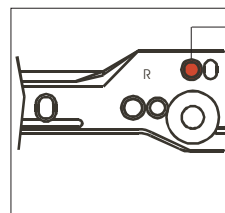
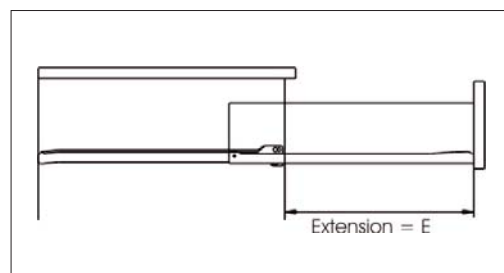

In case of heavy load fix
an additional screw in the
stated position.

Key **

Set finishing		
1	RAL 9001	White
F	RAL 9005	Black
D	RAL 8017	Brown

Packing	
I	Industrial
S	25 set
P	Single set

Ferrari hold the right to alter or amend any technical or structural specifications at any time without notice

ITALY
Agostino Ferrari S.p.a.
I - 23878 Verderio S. (LC) Via per Cornate
Tel. ++39.039.59001 - Fax ++39.039.5900222
Web Site://www.ferrarispa.it - e-mail: ferrarispa@ferrarispa.it

U.S.A.
Ferrari America INC.
4189 Eagle Hill Drive - Suite 110 - High Point - North Carolina - 27265 - U.S.A.
Tel. 001 336 8411445 - Fax 001 336 8413543
Web Site://www.ferrariamerica.com - e-mail: info@ferrariamerica.com

GREECE
Ferrari Greece LTD
101 Syngrou Avenue - 11745 Athens -Greece
Tel. 0030 210 9211838 - Fax 0030 210 9211836
e-mail: ferrarinikos@internet.gr

GERMANY
Agostino Ferrari Germany GMBH
Im Meisenfeld 5 - 32602 Vlotho - Exter Germany
Tel. 0049 5228 96080 - Fax 0049 5228 960824
Web Site://www.ferrari-fittings.de - e-mail: ferrari@ferrari-fittings.de

U.K.
Agostino Ferrari (UK) LTD Units H & L
Strawberry Street Industrial Estate HU9 1EN Hull East Yorkshire - U.K.
Tel. 0044 1482 59450 - Fax 0044 1482 59455
Web site://www.aferrariuk.com - e-mail: info@aferrariuk.com